

DIMENSIONS ARE CORRECT AT TIME OF PRINTING AND MAY ALTER WITHOUT PRIOR NOTIFICATION

PORT SCHEDULE

PORTS	SIZE	DESCRIPTION
G	50mm	GAS CONNECTION
M	65mm	BOILER OUTLET
R	65mm	BOILER INLET
S	40mm	CONDENSATE DRAIN
D	Ø150/200	FLUE

NOTE

1. BOILER SHOWN WITH R.H. SIDE CONNECTIONS (GAS & WATER) CAN BE SUPPLIED WITH L.H. SIDE CONNECTIONS (GAS & WATER)
2. SHADED AREA DENOTES MAINTENANCE AND INSTALLATION CLEARANCES

OPTIONAL FLUE LOCATIONS

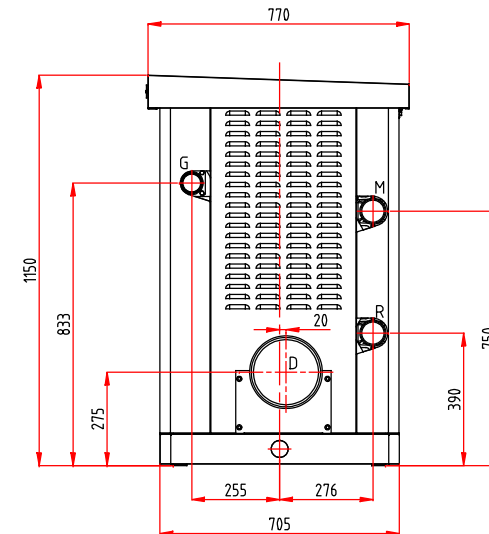
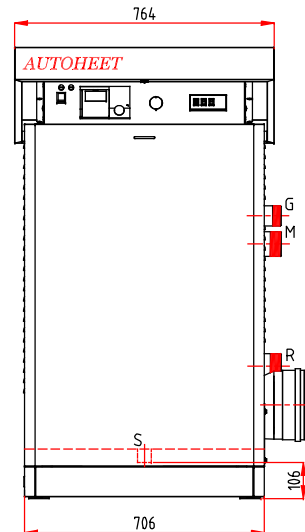
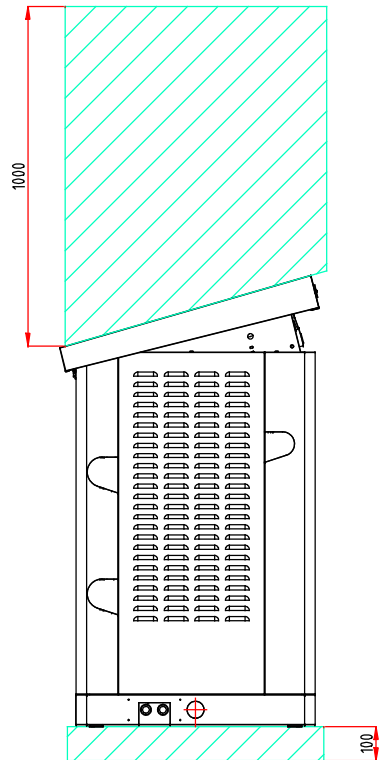
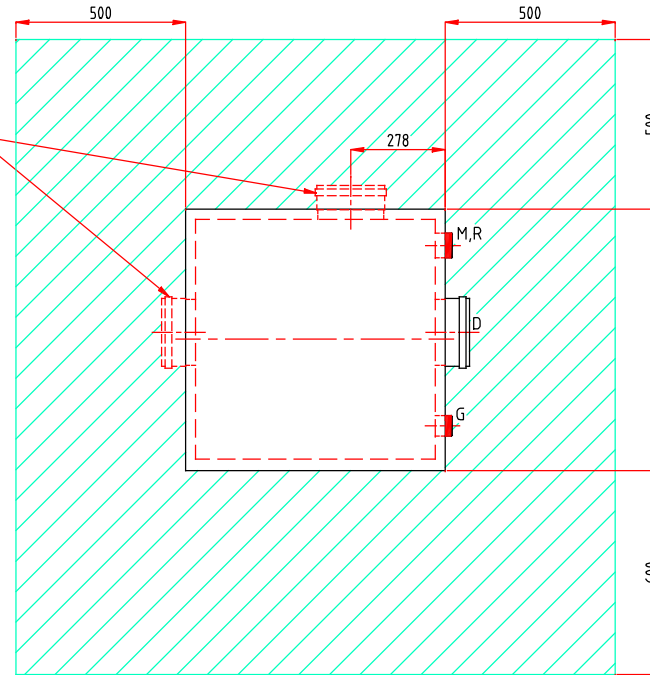

PICTORIALLY REVISED	G.R.	08/08/12	B	NAME: G.ROBERTS	CLIENT:	AUTOMATIC HEATING PTY LTD 67 GATEWAY BOULEVARD EPPING, VICTORIA 3076 AUSTRALIA Phone : +61 3 9330 3300 Fax : +61 3 9310 5655	SIZE	DRG No.	REV.
ORIGINAL ISSUE	G.R.	15/01/11	A	DATE: 15/01/11	TITLE: MODULEX EXT HEATING BOILER MODEL 150		A3	MOD-EXT-150	B
MODIFICATION	NAME	DATE	REV	QUOTE No.			SCALE:	1:15	